

Ecophon Solo™ Baffle

Solo Baffle is vertically installed unframed baffles. Solo Baffle can be used to form distinct lines and is available in different sizes and a wide range of colours. Baffles are used primarily when natural light is brought into the room via skylight.



Plantronics, Hoofddorp, Netherlands

SYSTEM RANGE

Size, mm	1200x200	1200x300	1200x600	1800x200	1800x300	1800x600
Special	•	•	•	•	•	•
Thickness (THK)	40	40	40	40	40	40
Inst. Diagr.	M414, M491	M414	M414, M491	M414, M491	M414, M491	M414, M491

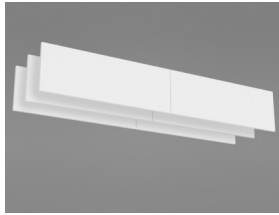

Solo Baffle

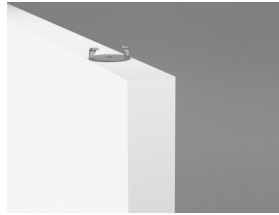

Solo Baffle/anchor



Solo Baffle/anchor installation

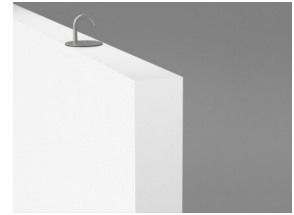

Solo Baffle/hook



Acoustic

Sound Absorption:

Test results according to EN ISO 354:2003 NOTE: Results shown are not comparable with results according to older versions of this standard due to discrepancies in test method. Classification according to EN ISO 11654, and the single value ratings for Noise Reduction Coefficient, NRC and Sound Absorption Average, SAA according to ASTM C 423.

α_p , Practical sound absorption coefficient

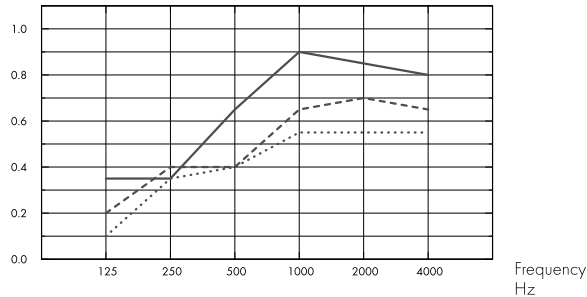

- ... Solo Baffle 1200/1800x200, spacing 600mm, direct mounting
- Solo Baffle 1200/1800x300, spacing 600mm, direct mounting
- Solo Baffle 1200/1800x600, spacing 600mm, direct mounting

A_{eq} , Equivalent absorption area per unit (m² sabin)

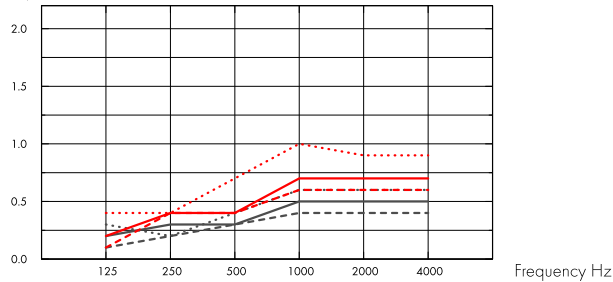

- Solo Baffle 1200x200
- Solo Baffle 1200x300
- ... Solo Baffle 1200x600
- . - Solo Baffle 1800x200
- - - Solo Baffle 1800x300
- . . Solo Baffle 1800x600

	THK mm	o.d.s. mm	α_p , Practical sound absorption coefficient						α_w
			125 Hz	250 Hz	500 Hz	1000 Hz	2000 Hz	4000 Hz	
c600	40	200	0.10	0.35	0.40	0.55	0.55	0.55	0.50
c600	40	300	0.20	0.40	0.40	0.65	0.70	0.65	0.50
c600	40	600	0.35	0.35	0.65	0.90	0.85	0.80	0.65

	THK mm	o.d.s. mm	A_{eq} , Equivalent absorption area per unit (m ² sabin)					
			125 Hz	250 Hz	500 Hz	1000 Hz	2000 Hz	4000 Hz
1200x200c600	40	200	0.1	0.2	0.3	0.4	0.4	0.4
1200x300c600	40	300	0.2	0.3	0.3	0.5	0.5	0.5
1200x600c600	40	600	0.3	0.2	0.4	0.6	0.6	0.6
1800x200c600	40	200	0.1	0.4	0.4	0.6	0.6	0.6
1800x300c600	40	300	0.2	0.4	0.4	0.7	0.7	0.7
1800x600c600	40	600	0.4	0.4	0.7	1.0	0.9	0.9



Indoor Air Quality

Certificate / Label

Eurofins Indoor Air Comfort®	IAC
French VOC	A
Finnish M1	•



Environmental Footprint

Kg CO₂ equiv/m²

Solo Baffle	10,11 (Solo Family EPD in conformity with ISO 14025 / EN 15804)
-------------	---



Circularity

Minimum post-consumer recycled content	57%
Recyclability	Fully recyclable



Fire safety

Country	Standard	Class
Europe	EN 13501-1	A2-s1,d0

The glass wool core of the tiles is tested and classified as non-combustible according to EN ISO 1182.



Humidity Resistance

Class C, relative humidity 95% and 30°C, according to EN 13964:2014



Visual appearance

White Frost, nearest NCS colour sample S 0500-N, 85% light reflectance. Gloss < 1.



Cleanability

Daily dusting and vacuum cleaning. Weekly wet wiping.



Accessibility

The tiles are demountable.



Installation

Installed according to installation diagrams, installation guides and drawing aid. For information regarding minimum overall depth of system see quantity specification.



System weight

Approximate weight of system 2-4 kg/m



Mechanical properties

Additional live load has to be fixed to the soffit.

**CE**

Ecophon ceiling systems are CE marked according to the European harmonized standard EN 13964:2014. CE marked construction products are covered by a Declaration of Performance (DOP) which enables customers and users to easily compare performance of products available on the European market.

INSTALLATION DIAGRAM (M414) FOR ECOPHON SOLO BAFFLE/ANCHOR

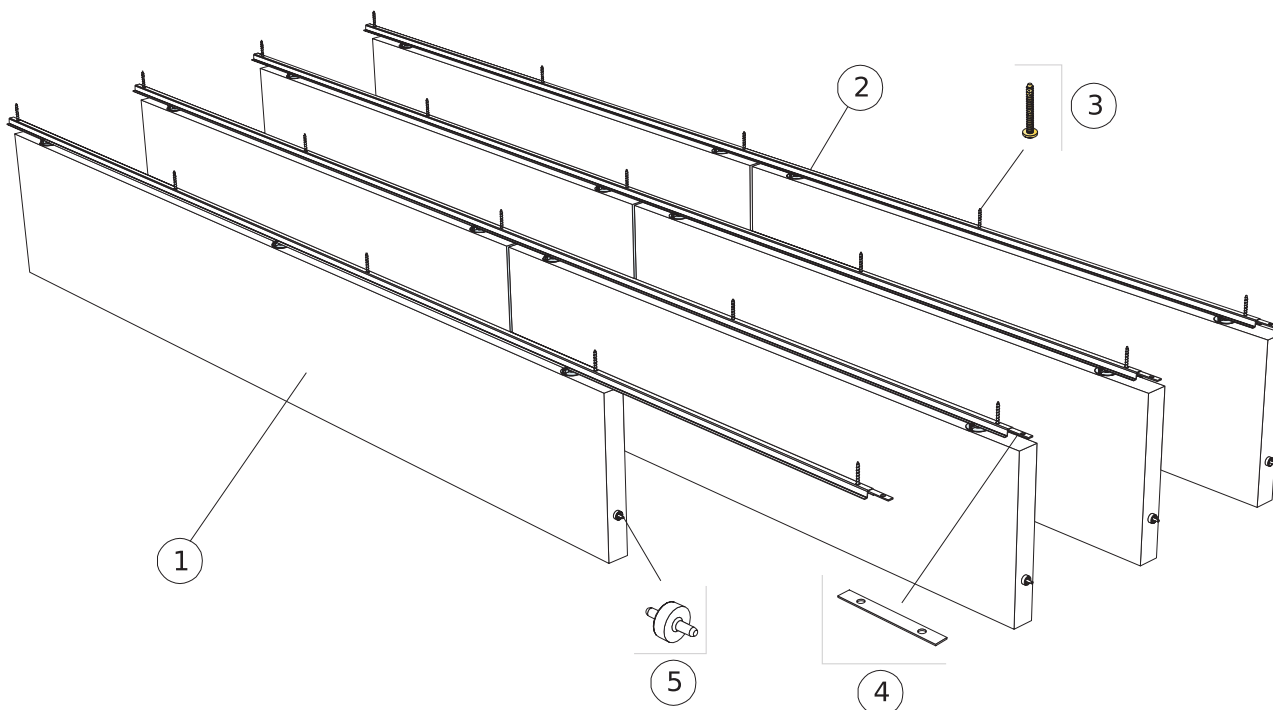

QUANTITY SPECIFICATION (EXCL. WASTAGE)

	Size, mm					
	1200x200	1200x300	1200x600	1800x200	1800x300	1800x600
1 Solo Baffle/anchor, installed at 300 mm centres	2,8/m ²	2,8/m ²	2,8/m ²	1,9/m ²	1,9/m ²	1,9/m ²
2 Connect Baffle profile, installed at 300 mm centres	3,3m/m ²	3,3m/m ²	3,3m/m ²	3,3m/m ²	3,3m/m ²	3,3m/m ²
3 Connect Anchor screw, fixed at 1200 mm centres	2,8/m ²	2,8/m ²	2,8/m ²	2,8/m ²	2,8/m ²	2,8/m ²
4 Connect Profile connector, installed at 2400 mm centres	1,4/m ²	1,4/m ²	1,4/m ²	1,4/m ²	1,4/m ²	1,4/m ²
5 Connect Guiding pin, installed at 1200/1800 mm centres	2,8/m ²	2,8/m ²	2,8/m ²	1,9/m ²	1,9/m ²	1,9/m ²

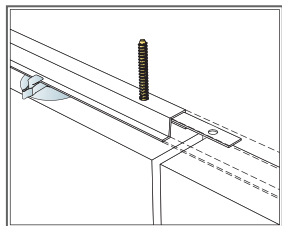

Fixing of Connect Profile connector

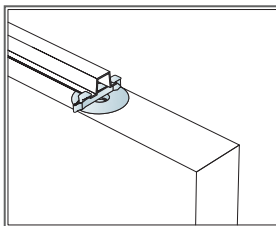

The baffles are secured with clips

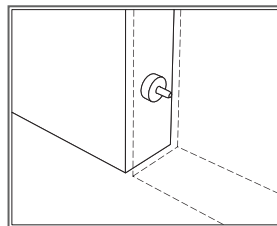

Connect Guiding pin, used to fix distance and level between panels

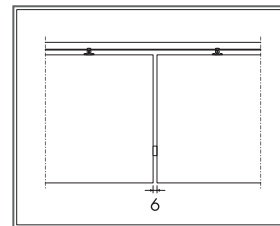

Distinct gap of 6 mm between baffles with Connect Guiding pin

INSTALLATION DIAGRAM (M491) FOR ECOPHON SOLO BAFFLE/HOOK

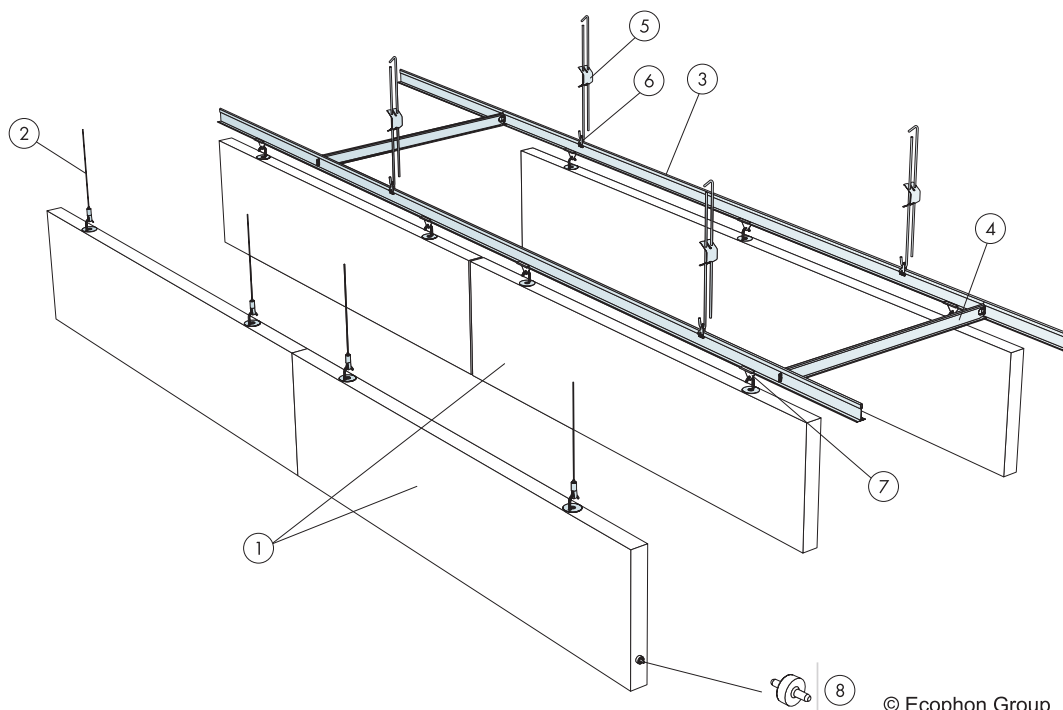

QUANTITY SPECIFICATION (EXCL. WASTAGE)

	Size, mm				
	1200x200	1200x600	1800x200	1800x300	1800x600
1 Solo Baffle/hook, installed at 600 mm centres	1,4/m ²	1,4/m ²	0,9/m ²	0,9/m ²	0,9/m ²
2 Connect Adjustable wire hanger (Alt 1)	2/panel	2/panel	3/panel	3/panel	3/panel
3 Connect T24 Main runner, installed at 600 mm centres (Alt 2)	1,7m/m ²	1,7m/m ²	1,7m/m ²	1,7m/m ²	1,7m/m ²
4 Connect T24 Cross tee, L=600 mm, installed at 1800 mm centres (Alt 2)	0,6m/m ²	0,6m/m ²	0,6m/m ²	0,6m/m ²	0,6m/m ²
5 Connect Adjustable hanger (Alt 2) c1200	1,4/m ²	1,4/m ²	1,4/m ²	1,4/m ²	1,4/m ²
6 Connect Hanger clip (Alt 2)	1,4/m ²	1,4/m ²	1,4/m ²	1,4/m ²	1,4/m ²
7 Connect Baffle clip (Alt 2)	2,8/m ²	2,8/m ²	2,8/m ²	2,8/m ²	2,8/m ²
8 Connect Guiding Pin, installed at 1200/1800 mm centres	2,8/m ²	2,8/m ²	0,9/m ²	0,9/m ²	0,9/m ²

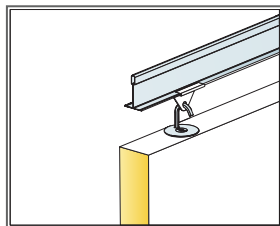

Detail of suspension

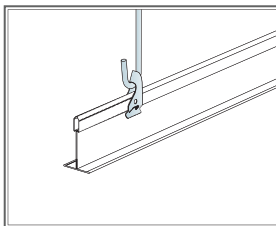

Suspension with adjustable hanger and clip

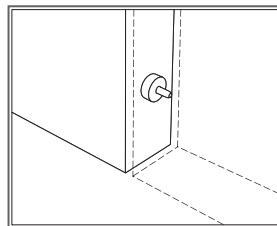

Connect Guiding pin, used to fix distance and level between panels

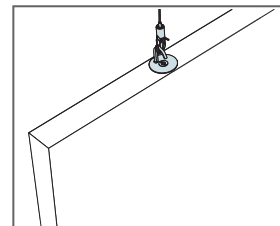

Suspension with Connect Adjustable wire hanger